

INSTALLATION NOTES:

1. FOOTING MATERIALS & INSTALLATION BY OTHERS. TOOLS BY OTHERS.
2. SCREWS AND BOLTS PROVIDED. LIGHT ELEMENT AND LIGHTING POWER ASSEMBLY PROVIDED. (SHIPPED SEPARATELY).
3. MAKE CONDUIT AND WIRING AVAILABLE THROUGH PIPE TO TOP OF BOLLARD INTERIOR.
4. CHOOSE DIRECTION WAYNE TYLER LOGO ON BOLLARD WALL SHOULD FACE. CAST-IN OR CORE DRILL (3) 1-1/2"DIA. x 5"DEEP GROUT POCKETS INTO FOOTING PER ANCHOR BOLT PATTERN.
5. TAKE (3) 1/2" DIA. x 4-1/2" LONG ANCHOR BOLTS AND SCREW AN INCH DEEP INTO (3) 1/2"DIA. S.S. THREADED INSERTS, LEAVING 3-1/2" OF THE ANCHOR BOLT EXPOSED.
6. FILL ALL GROUT POCKETS WITH NON-SHRINK GROUT. INSERT BOLLARD WITH ANCHOR BOLTS INTO GROUT POCKETS.
7. TAKE LIGHT POWER ASSEMBLY AND WITH POWER SOURCE DISCONNECTED, ENSURE GROUND WIRE IS CONNECTED APPROPRIATELY.
8. MAKE WET LOCATION CONNECTIONS WITH AC WIRES AT THE AC-IN SIDE OF THE DRIVER. WHITE IS NEUTRAL, BLACK IS POSITIVE.
9. MAKE WET LOCATION DIMMING CONNECTIONS IF REQUIRED/APPROPRIATE.
10. PLACE LIGHT POWER ASSEMBLY TO THE INSIDE LEDGE OF THE BOLLARD BODY.
11. MOUNT THE GRILLE TO THE BOLLARD BODY WITH THE 1/4" X 1" SCREWS USING A LONG T-HANDLE HEX WRENCH.
12. APPLY A BEAD OF CLEAR, HIGH TEMP, RTV 100% SILICONE TO BOTTOM OF ACRYLIC LENS AND PLACE LENS INSIDE GRILLE.
13. TEST TO ENSURE OPERATION.
14. MOUNT THE CAP TO THE GRILL WITH 1/4" X 1" SCREWS.

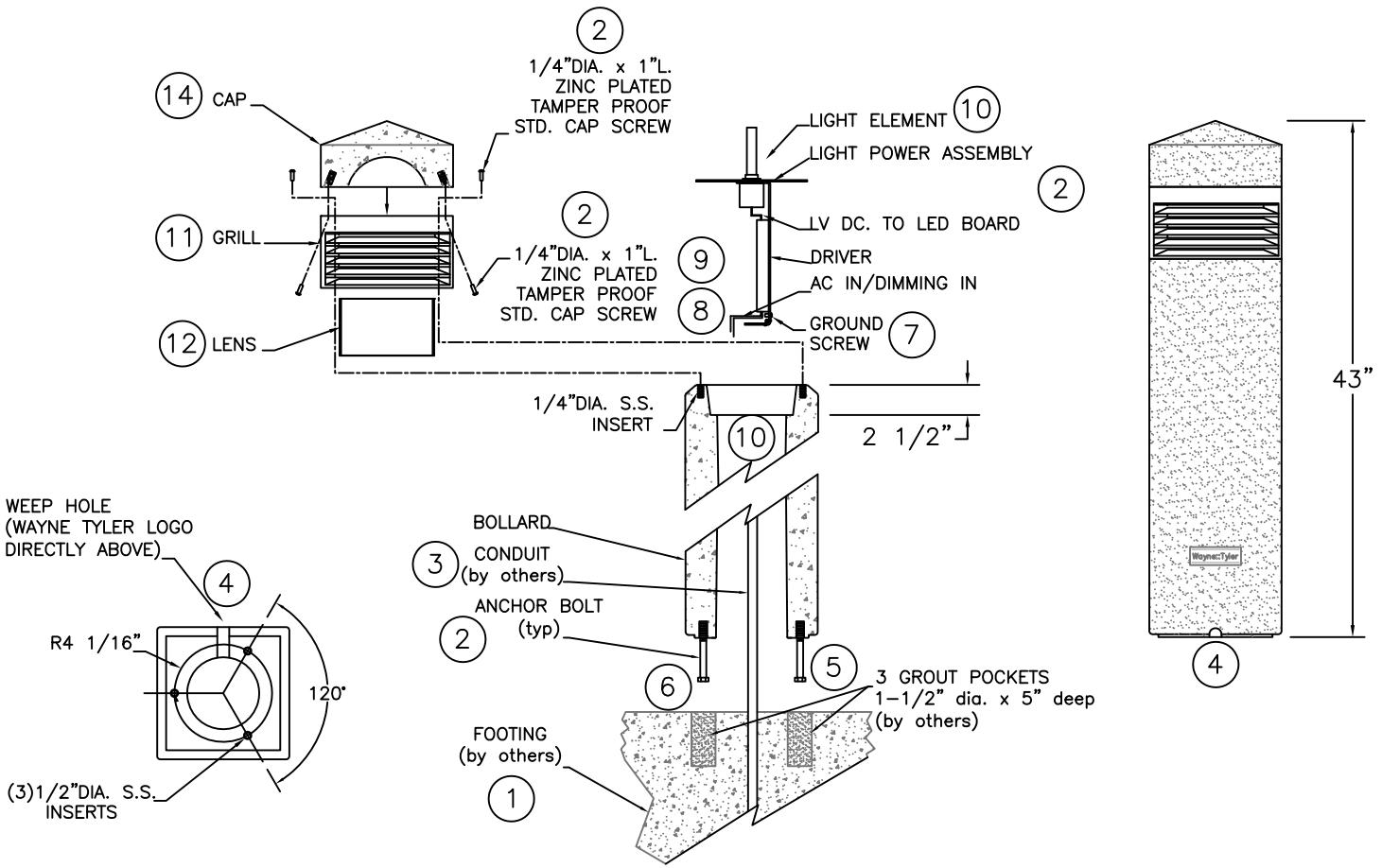

ANCHOR BOLT PATTERN

BOLLARD PAD MOUNT DETAIL

ELEVATION



"CUT-AWAY" GRAPHIC REVEALS INTERNAL CONDUIT. ACTUAL PIPE IS INTACT. MOUNTING AND INSTALLATION INSTRUCTION SUBJECT TO CHANGE/UPDATE. SEEK THE MOST RECENT VERSION. 6/2017

	PLAN TYPE:	MOUNTING AND INSTALLATION	DATE:	06/01/17	FILE NO.	223	SHEET 1 OF 1
	PRODUCT:	223-LIGHTED CONCRETE BOLLARD	SCALE:	AS NOTED	DRAWN BY:	BGH	
	MOUNTING TYPE:	SECURITY MOUNT					